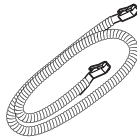
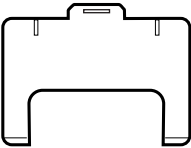
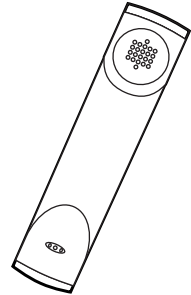
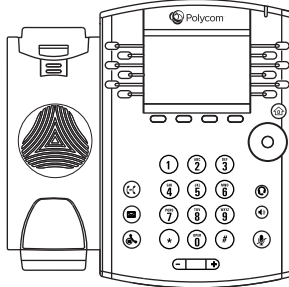
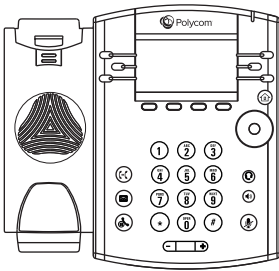

**VVX 300/301/
310/311**

**VVX 400/401/
410/411**

Note: For more information on your Polycom® VVX® 300 series and VVX 400 series business media phones, see user documentation, including Quick User Guides and User Guides, on your phone's Support page on Polycom Voice Support:
http://support.polycom.com/PolycomService/support/us/support/voice/business_media_phones/

Package Contents

VVX 300 Series Phone
VVX 400 Series Phone

Optional Accessories

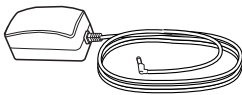
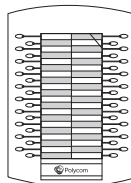
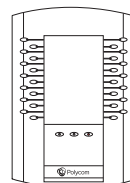
AC power adapter
(varies by region)

VVX Expansion Module
(paper display)

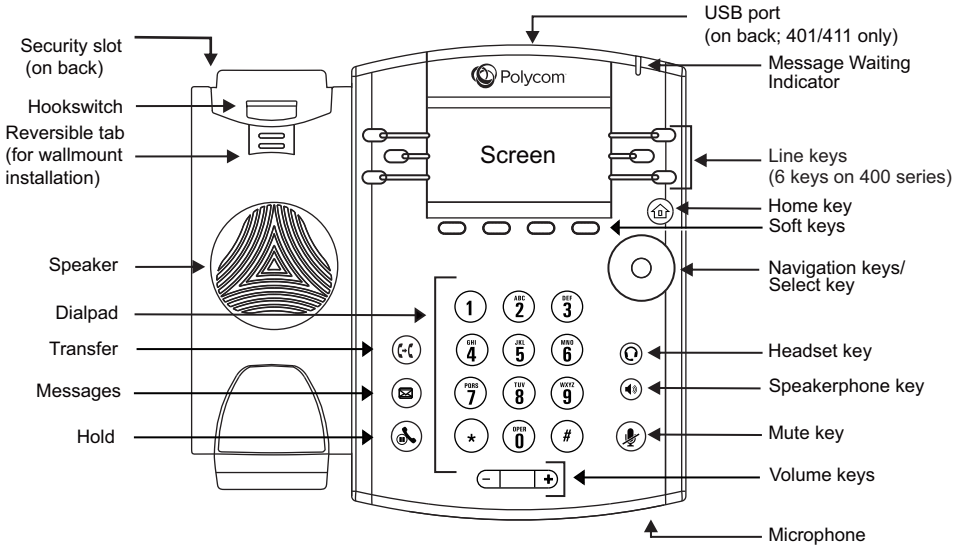
VVX Expansion Module
(LCD color display)

Features

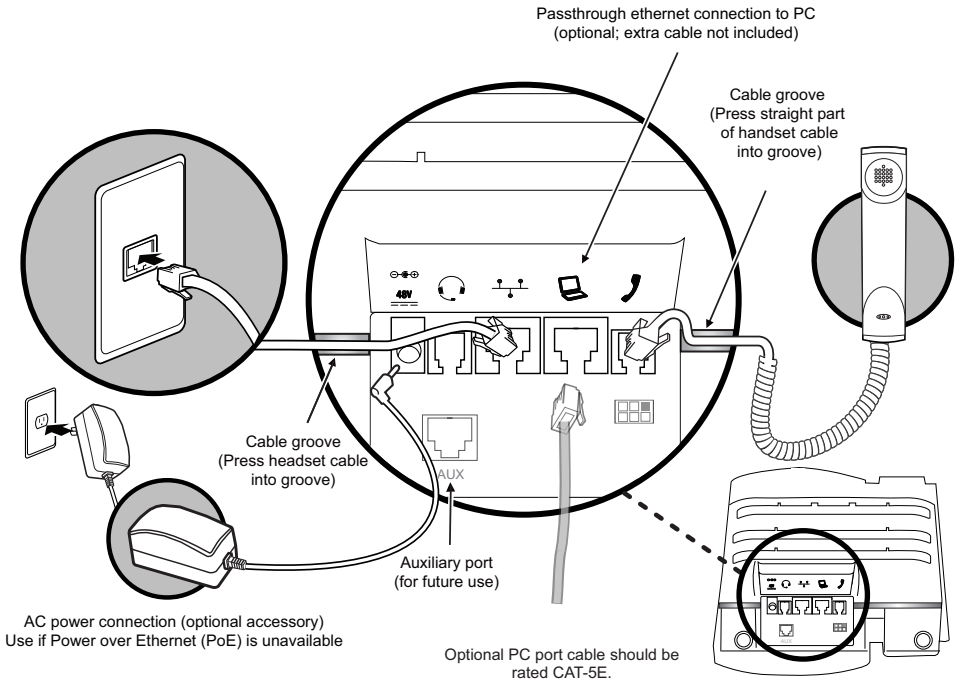

Connect Cables



Connect Stand*

Fully insert the stand into one of the slots on the back of the phone. The slot you choose determines the angle of the phone.

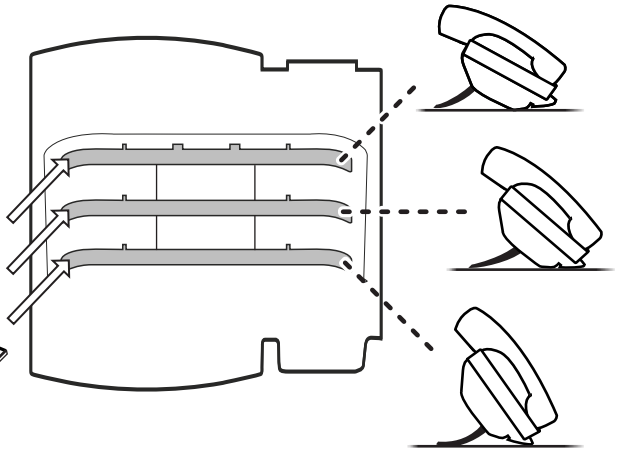
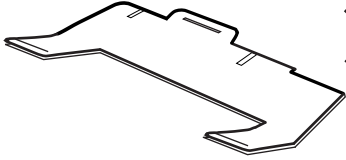

*For wallmount installation, an optional accessory is available. For more information, contact your reseller.

Connect Optional Headset

Note: Your phone supports wired headsets, including electronic hookswitch (EHS) headsets.

For connection directions, refer to your headset documentation. Standard headsets typically use the RJ-9, while EHS headsets use the RJ-9 and serial port.

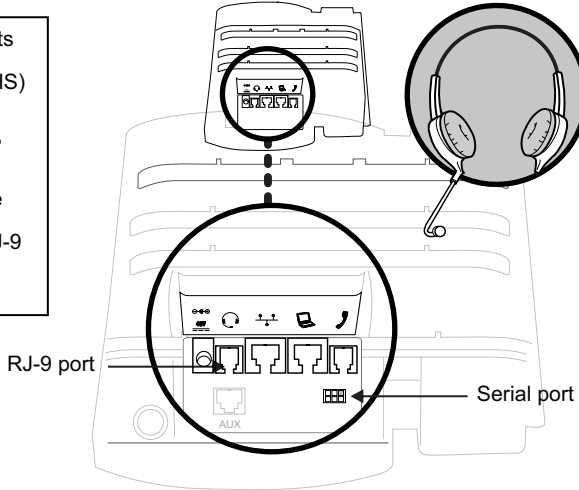

Connect Optional USB Devices

On VVX 401/411 phones, you can attach a USB headset, or a USB flash drive to record calls, use the Digital Picture Frame feature, or to change the background picture on your phone. To learn more, see your phone's User Guide.

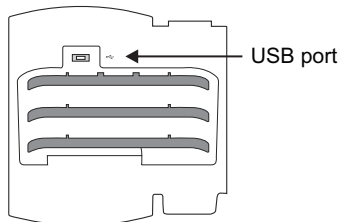

Copyright, Safety Notices

LIMITED WARRANTY. Polycom warrants to the end user ("Customer") that this product will be free from defects in workmanship and materials, under normal use and service, for one year from the date of purchase from Polycom or its authorized reseller. Polycom's sole obligation under this express warranty shall be, at Polycom's option and expense, to repair the defective product or part, deliver to Customer an equivalent product or part to replace the defective item, or if neither of the two foregoing options are reasonably available, Polycom may, on its sole discretion, refund to Customer the purchase price paid for the defective product. All products that are replaced will become the property of Polycom. Replacement products or parts may be new or reconditioned. Polycom warrants any replaced or repaired product or part for ninety (90) days from shipment, or the remainder of the initial warranty period, whichever is longer. Products returned to Polycom must be sent prepaid and packaged appropriately for safe shipment, and it is recommended that they be insured or sent by a method that provides shipping to the defecting product or part, deliver to Customer an equivalent product or part until the returned item is received by Polycom. The repaired or replaced item will be shipped to Customer, at Polycom's expense, not later than thirty (30) days after Polycom receives the defective product, and Polycom will retain risk of loss or damage until the item is delivered to Customer.

EXCLUSIONS. Polycom will not be liable under this limited warranty if its testing and examination disclose that the alleged defect or malfunction in the product does not exist or results from:

- Failure to follow Polycom's installation, operation, or maintenance instructions.
- Unauthorized product modification or alteration.
- Unauthorized use of common carrier communication services accessed through the product.
- Abuse, misuse, negligent acts or omissions of Customer and persons under Customer's control;
- Acts of third parties, acts of God, accident, fire, lightning, power surges or outages, or other hazards.

WARRANTY EXCLUSIVE. IF A POLYCOM PRODUCT DOES NOT OPERATE AS WARRANTED ABOVE, CUSTOMER'S SOLE REMEDY FOR BREACH OF THAT WARRANTY SHALL BE THE RETURN OF THE PRODUCT FOR A FULL REFUND OF THE PURCHASE PRICE PAID, AT POLYCOM'S OPTION. TO THE FULL EXTENT ALLOWED BY LAW, THE FOREGOING WARRANTIES AND REMEDIES ARE EXCLUSIVE AND ARE IN LIEU OF ALL OTHER WARRANTIES, TERMS, OR CONDITIONS, EXPRESS OR IMPLIED, EITHER IN FACT OR BY OPERATION OF LAW, STATUTORY OR OTHERWISE, INCLUDING WARRANTIES, TERMS, OR CONDITIONS OF MERCHANTABILITY, FITNESS FOR A PARTICULAR PURPOSE, SATISFACTORY QUALITY, CORRESPONDENCE WITH DESCRIPTION, AND NON-INFRINGEMENT, ALL OF WHICH ARE EXPRESSLY DISCLAIMED. POLYCOM NEITHER ASSUMES NOR AUTHORIZES ANY OTHER PERSON TO ASSUME OR ACCEPT ANY LIABILITY IN CONNECTION WITH THE SALE, INSTALLATION, MAINTENANCE OR USE OF ITS PRODUCTS.

SERVICE AGREEMENTS. Please contact your Polycom Authorized Reseller for information about service agreements applicable to your product.

UNAUTHORIZED SUPPORT. Polycom will provide support for software running on the Product if all of the following conditions are satisfied:

- The product is under warranty or is covered by a Polycom service contract;

CE Mark R & TTE Directive (EU Only)

Polycom (UK) Ltd tímto prohlašuje, že tento Polycom VVX 300/301/310/311/400/401/410/411 je v shodě se základními požadavky a dalšími příslušnými ustanoveními směrnice 1999/5/EC.

Underneath Polycom (UK) Ltd erklærer herved, at følgende udstyr Polycom VVX 300/301/310/311/400/401/410/411 overholder de væsentlige krav i direktivet 1999/5/EC.

Hiermit erklärt Polycom (UK) Ltd, dass sich das Gerät Polycom VVX 300/301/310/311/400/401/410/411 in Übereinstimmung mit den grundlegenden Anforderungen und den übrigen einschlägigen Bestimmungen der

Käselegislativ kinnitab Polycom (UK) Ltd seadme Polycom VVX 300/301/310/311/400/401/410/411 vastavast direktiivi 1999/5/EC põhinõuetele ja meetutud direktiivi täiendavatele teistele asjakohastele sätetele.

Hereby, Polycom (UK) Ltd declares that this Polycom VVX 300/301/310/311/400/401/410/411 is in compliance with the essential requirements and other relevant provisions of the directive 1999/5/EC.

Por medio de la presente Polycom (UK) Ltd declara que el dispositivo Polycom VVX 300/301/310/311/400/401/410/411 cumple con los requisitos esenciales y cualesquiera otras disposiciones aplicables o exigibles de la Directiva 1999/5/CE.

Με την παρούσα Polycom (UK) Ltd δηλώνει ότι η συσκευή Polycom VVX 300/301/310/311/400/401/410/411 συμμορφώνεται προς τις ουσιαστικές απαιτήσεις και τα λοιπά σχετικά διατάγματα της οδηγίας 1999/5/ΕΚ.

Par la présente Polycom (UK) Ltd déclare que l'appareil Polycom VVX 300/301/310/311/400/401/410/411 est conforme aux exigences essentielles et autres dispositions pertinentes de la directive 1999/5/CE.

Con la presente Polycom (UK) Ltd dichiara che questo Polycom VVX 300/301/310/311/400/401/410/411 rispetta i requisiti essenziali ed altre disposizioni pertinenti stabilite dalla direttiva 1999/5/CE.

Hermed jser Polycom (UK) Ltd yfyr að Polycom VVX 300/301/310/311/400/401/410/411 er í samræmi við ástæðulega og öðrum eiginlegum kröfum áttíu (90) daga vottorðs frá afhöfu.

Bizás kijelölés Polycom (UK) Ltd deklará, že tento Polycom VVX 300/301/310/311/400/401/410/411 splňuje základní požadavky a ostatní příslušná ustanovení směrnice 1999/5/EC.

SAFETY AND REGULATORY INFORMATION.

This device complies with Part 15 of the FCC Rules. Operation is subject to the following two conditions:

- (1) This device may not cause harmful interference, and
- (2) This device must accept any interference received, including interference that may cause undesired operation.

NOTE: This device has been tested and found to comply with the limits for a Class B digital device, pursuant to part 15 of the FCC Rules. These limits are designed to provide reasonable protection against harmful interference in a residential installation. This equipment generates, uses and can radiate radio frequency energy and, if not installed and used in accordance with the instructions, may cause harmful interference to radio communications. However, there is no guarantee that interference will not occur in a particular installation. If your equipment does cause harmful interference to radio or television reception, which can be determined by turning the equipment off and on, the user is encouraged to try to correct the interference by one or more of the following measures:

- Reorient or relocate the receiving antenna.
- Increase the separation between the equipment and receiver.
- Connect the equipment into an outlet on a circuit different from that to which the receiver is connected.
- Consult the dealer or an experienced radio/TV technician for help.

Hereby, Polycom (UK) declares that the products in this manual are CE marked and in compliance with all EU directives and regulations that apply to them including: R&TTE Directive 1999/5/EC. A full copy of the Declaration of Conformity can be obtained from Polycom Ltd., 270 Bath Road, Slough, Berkshire, SL1 4DX, UK.

In accordance with Part 15 of the FCC Rules, the user is cautioned that any changes or modifications not expressly approved by Polycom, Inc. could void the user's authority to operate the equipment.

- Operating Ambient Conditions:
- Operating temperature: +32 to 104°F (+0 to 40°C)
 - Relative humidity: 5% to 95%, non-condensing
 - Storage temperature: -40 to +160°F (-40 to +70°C)

Installation must be performed in accordance with all relevant national wiring rules. Installation doit être exécutée conformément à tous les règlements nationaux applicables au filage électrique.

The outlet to which this apparatus is connected must be installed near the equipment and must always be readily accessible. La prise électrique à laquelle l'appareil est branché doit être facilement accessible. The equipment and its power cord must be connected to a PoE network without connections to the outside plant.

Lorsque vous utilisez une alimentation électrique par câble ethernet (PoE - Power over

- The product software is the current major version or the next preceding major version (software revisions are labeled as "x.y.z," with the first two digits designating major versions).
- The product software comes with 90-day software warranty, providing for software updates (minor releases/bug fixes). To continue to receive support, purchasing a maintenance contract is the most economical solution.

Requests for software support should be made through the Polycom Reseller from whom the product was purchased.

LIMITED WARRANTY TO THE FULL EXTENT ALLOWED BY LAW. POLYCOM EXCLUDES FOR ITSELF AND ITS SUPPLIERS ANY LIABILITY, WHETHER BASED IN CONTRACT OR TORT (INCLUDING NEGLIGENCE), FOR INCIDENTAL, CONSEQUENTIAL, INDIRECT, SPECIAL, OR PUNITIVE DAMAGES OF ANY KIND, OR FOR LOSS OF REVENUE OR PROFITS, LOSS OF BUSINESS, LOSS OF USE OR DATA, OR OTHER FINANCIAL LOSS ARISING OUT OF OR IN CONNECTION WITH THE SALE, INSTALLATION, MAINTENANCE, USE, PERFORMANCE, FAILURE, OR INTERRUPTION OF ITS PRODUCTS, EVEN IF POLYCOM OR ITS AUTHORIZED RESELLER HAS BEEN ADVISED OF THE POSSIBILITY OF SUCH DAMAGES, AND LIMITS ITS LIABILITY TO REPAIR, REPLACEMENT, OR REFUND OF THE PURCHASE PRICE PAID, AT POLYCOM'S OPTION. THIS DISCLAIMER OF LIABILITY FOR DAMAGES WILL NOT BE AFFECTED IF ANY REMEDY PROVIDED HEREIN SHALL FAIL OF ITS ESSENTIAL PURPOSE.

DISCLAIMER. Some countries, states, or provinces do not allow the exclusion or limitation of implied warranties or the limitation of incidental or consequential damages for certain products supplied to consumers, or the limitation of liability for personal injury, so the above limitations and exclusions may be limited in their application to you. When the implied warranties are not allowed to be excluded in their entirety, they will be limited to the duration of the applicable warranty. This warranty gives you specific legal rights, which may vary depending on local law.

GOVERNING LAW. This Limited Warranty and Limitation of Liability shall be governed by the laws of the State of California, U.S.A., and by the laws of the United States, excluding their conflicts of laws principles. The United Nations Convention on Contracts for the International Sale of Goods (CISG) shall not apply to this warranty and limitation of liability. All rights reserved under International and Pan-American Copyright Conventions. No part of the contents of this manual may be copied, reproduced, or transmitted in any form or by any means, or translated into another language or format, in whole or part, without written consent from Polycom, Inc. The content of this manual may vary without notice from other product identification, copyright or other notices. Polycom, the Polycom logo design, and Polycom VVX 300/301, 310/311, 400/401, and 410/411 are trademarks of Polycom, Inc. in the U.S. and various other countries.

COPYRIGHT. All rights reserved under International and Pan-American Copyright Conventions. No part of the contents of this manual may be copied, reproduced, or transmitted in any form or by any means, or translated into another language or format, in whole or part, without written consent of Polycom, Inc. Polycom® and the logo design are registered trademarks and Polycom VVX 300/301, 310/311, 400/401, and 410/411 are trademarks of Polycom, Inc. in the United States and various countries. Do not remove (or allow any third party to remove) any product identification, copyright or other notices.

Šuo Polycom (UK) Ltd deklaruja, kad šis Polycom VVX 300/301/310/311/400/401/410/411 atbilstiek esmiesm rakstavakm ir citas 1999/5/EB Direktivas noteiktas.

Hierby verklaar Polycom (UK) Ltd dat het toestel Polycom VVX 300/301/310/311/400/401/410/411 in overeenstemming is met de essentiële eisen en de andere relevante bepalingen van richtlijn 1999/5/EG.

Harnekk, Polycom (UK) Ltd, jildikšara ik dan Polycom VVX 300/301/310/311/400/401/410/411, jkkon-foma ma-hetigstj essenzjaln ja su provjedivnih ohranj relevantn i hemm Rk-Direktiva 1999/5/EC.

Alulorult, Polycom (UK) Ltd nylatkoo, hogy a Polycom VVX 300/301/310/311/400/401/410/411 megfelel a vonatkozó alapelvok követelményeinek és az 1999/5/EC irányelv egyéb előírásainak.

Polycom (UK) Ltd erklærer her ved at udstyret Polycom VVX 300/301/310/311/400/401/410/411 er i samsvare med de grundlæggende krav og øvrige relevante krav i direktiv 1999/5/EC.

Niniejszym Polycom (UK) Ltd oświadczam, że Polycom VVX 300/301/310/311/400/401/410/411 jest zgodne z zasadniczymi

wymaganiami, które musi spełniać urządzenie Polycom VVX 300/301/310/311/400/401/410/411 i składa się z elementów koniecznych do jego prawidłowego działania.

Polycom (UK) Ltd jildikšara, da šis Polycom VVX 300/301/310/311/400/401/410/411 atbilstu a zivertiemu noteikumiem un citiemu 1999/5/EC Direktivā prasītiem.

Polycom (UK) Ltd yfyr að Polycom VVX 300/301/310/311/400/401/410/411 er í samræmi við ástæðulega og öðrum eiginlegum kröfum áttíu (90) daga vottorðs frá afhöfu.

Hiermit erkläre Polycom (UK) Ltd dass dieses Polycom VVX 300/301/310/311/400/401/410/411 die wesentlichen Anforderungen und die übrigen einschlägigen Bestimmungen der Richtlinie 1999/5/EG erfüllt.

Harmed iđnyar Polycom (UK) Ltd deklará, že tento Polycom VVX 300/301/310/311/400/401/410/411 splňuje vŕesnostnemele med de væsentlige egenkrav og øvrige relevante bestemmelser som frangår av direktiv 1999/5/EC.

Ethernet), l'équipement doit être connecté uniquement aux réseaux PoE sans connexions vers l'extérieur de l'usine.

This Class [B] digital apparatus complies with Canadian ICES-003. Cet appareil numérique de la classe [B] sera conforme à la norme NMB-003 du Canada.

To avoid electric shock, do not connect safety extra low voltage (SELV) circuits to telecommunication station network (TNV) circuits. LAN ports contain SELV circuit, and WAN ports contain TNV circuits. Some LAN and WAN ports both use RJ-45 connectors. Use caution when connecting cables. This product is rated 48Vdc, 0.25A. When used with the optional external power supply (PSA15A-480P or similar rated PSU), the power supply shall be a listed power supply with a LPS output, rated 48V, min. 0.25A.

Afin d'éviter les chocs électriques, ne pas connecter les circuits de tension extra-basse de sécurité (SELV) à des circuits de réseau de stations de télécommunication (TNV). Les ports LAN contiennent un circuit SELV et les ports WAN contiennent des circuits TNV. Certains ports LAN et WAN utilisent tous deux des connecteurs RJ-45. Faites preuve de prudence lors de la connexion des câbles. Ce produit est classé 48 Vcc, 0,25 A. Lorsqu'il est utilisé avec le bloc d'alimentation externe facultatif, (PSA15A-480P, ou une alimentation semblable), l'alimentation électrique doit être répertoriée et marquée d'une sortie LPS, possédant les caractéristiques suivantes: 48V, 0,25A/Min.

Para evitar choques eléctricos, no conecte los circuitos de tensión extra-baja de seguridad (SELV) a los circuitos de red de estaciones de telecomunicaciones (TNV). Los puertos LAN contienen un circuito SELV y los puertos WAN contienen circuitos de TNV. Algunos puertos LAN y WAN utilizan tanto conectores RJ-45 como conectores de seguridad (SELV) a los puertos de red de estaciones de telecomunicaciones (TNV). Los puertos LAN contienen un circuito SELV y los puertos WAN contienen des circuitos TNV. Certains ports LAN et WAN utilisent tous deux des connecteurs RJ-45. Faites preuve de prudence lors de la connexion des câbles. Ce produit est classé 48 Vcc, 0,25 A.

Am 2013. En outre, toutes les sources PoE doivent satisfaire aux exigences de source d'alimentation limitée de la IEC 60950-1:2005 (2ème édition); Am1:2009 ou IEC 60950-1:2005 (2ème édition); Am1:2009; Am2:2013.

Hearing Aid Compatibility (HAC). This device is hearing aid compatible. ReHdS: All Polycom phones comply with the requirements of the IEC RoHS Directive. Statements of compliance can be obtained from TypeApproval@polycom.com

Ausstattung für Hörschwerhörige (HAC). Dieses Gerät ist hörschwerhörigen kompatibel. ReHdS: Alle Polycom-Telefone entsprechen den Anforderungen der IEC RoHS Richtlinie. Statements of compliance can be obtained from TypeApproval@polycom.com

Warning—This equipment will be inoperable when power fails. Japan:

この装置は、ラジエーション障害誘発装置です。この装置は、家庭環境で使用することを目的としています。この装置はラジオやテレビジョン受信機に近接して使用される場合、電磁干渉を引き起こすことがあります。

本装置は電磁波を発して電界電界を引き起こすことがあります。 VCCI-B

Please contact your Polycom Authorized Reseller for assistance.

<http://www.polycom.com>



1725-48490-001B